

Scope O 2.5" Round Wall Wash (64mm)

Formerly 4540

Fixed Recessed Wall Wash

Scope Original

The Scope Original is a small aperture downlight family used to great acclaim in thousands of projects over the last 20 years. This is our most efficient Scope Wall Wash fixture. With an easy retrofit type mounting option, we have expanded the offering with more source technology lumen packages and control options. You have found the Round Wall Wash Datasheet and we hope you enjoy the details.

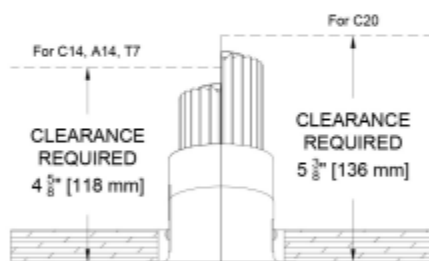

ROUND Wall Wash				
Source	System watts (W)	Delivered Lumens (lm)	Lumens/Watt	Peak cd
Citizen C14	14	1131	81	1443
Citizen C20	21	1540	74	9929
Ambient Dim A14	15	778	53	1011
Tunable White 1840	10	505	49	753
Tunable White 2765	10	621	61	953

Citizen and Ambient Dim data based on measurements at 3000k.
Tunable white data at midpoint CCT of color range.

For additional information see Photometric table and notes on page 5

PROJECT:

TYPE:

SPECIFIER:

DATE:

Key Points (SCOWW-R)

Trim

- Flange selection only
- Machined aluminum Body in USA
- 40 finish colors + custom and RAL available for trim flange and bezel. Finishes can be mixed and matched. See Finish Guide

Source / Optics

- 4:1 vertical illumination uniformity from top to bottom of 10' wall with 2.5' setback and 2.5' on center spacing
- Up to 1540 delivered lumens
- <2 MacAdams Ellipses (<2 SDCM) for static white points
- 90+ CRI, 60+ R9 Standard, 95+ CRI, 90+ R9 available with Ambient Dim option
- 2400K, 2700K, 3000K, 3500K, 4000K Ambient Dim, RGBW & Tunable White options
- Source meets California Tilt 24 Requirements to JA8

Housing

- Remodel mounting (wing springs) only
- rated damp, wet with shower trim and for use with contact to insulation (IC/Airtight) but not spray foam

Driver And Control

- Universal 120-277v
- Flicker free to IEEE 1789-2015 available with EldoLED and TruPhase™ selections
- TruPhase™, 0-10, DALI-2, DMX, Ecosystem or Wireless Control
- Drivers are integral with fixtures unless noted as remote mount with * in ordering code options. "K can" type drivers do not fit through the 2.5" hole

Scope O 2.5" Round Wall Wash (64mm)

Formerly 4540

Fixed Recessed Wall Wash



Ordering Codes

PROJECT:











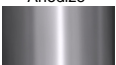

SPECIFIER:

DATE:

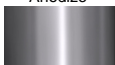
TYPE:

QUANTITY:

Ordering Code Example: SCOWW-R-F-C20-30-C1-A32-P14-LR

FIXTURE	TRIM	SOURCE / WATTS	CCT	DRIVER / CONTROL	BEZEL FINISH	TRIM FINISH	ACCESSORIES
SCOWW-R							
Scope Original 2.5" Wall Wash - Round	<p>F Flanged Trim</p> <p>FS Flanged Shower Trim</p>	<p>Citizen</p> <p>C14 ●● 14W 1131Lm 90+CRI, 60+R9</p> <p>C20 ●● 21W 1540Lm 90+CRI, 60+R9</p> <p>Tunable</p> <p>T7 ●● 10W 90+CRI, Tunable White</p> <p>T20 ●● 21W 1490Lm^ 90+CRI, 60+R9 Tunable White</p> <p>Ambient Dim™</p> <p>A14 ●● 15W 95+CRI,</p> <p>A20 ●● 21W 95+CRI,</p> <p>●● CA Title 24 Compliant</p> <p>+LTT or EidoLED driver selection required and will be supplied with 2 channel version</p>	<p>24 2400K</p> <p>27 2700K</p> <p>30 3000K</p> <p>35 3500K</p> <p>40 4000K</p> <p>Tunable</p> <p>TW1840 1800-4000K Tunable White w/ E1, E2, E3, E4</p> <p>TW2765 2700-6500K Tunable White w/ E1, E2, E3, E4</p> <p>Ambient Dim™</p> <p>2722* 2700-2200K *A14 Only</p> <p>3019 3000-1900K</p> <p>3022 * 3000-2200K *A14 Only</p> <p>* Not compliant with California Title 24</p>	<p>C1 0-10 1.0%, UNV (120-277V) linear</p> <p>C2 ELV/Triac 1.0%, (120V) linear</p> <p>E1 0-10* 0.1%, UNV (120-277V) log</p> <p>E2 DALI-2* 0.1%, UNV (120-277V) log</p> <p>E3 0-10* 0.1%, UNV (120-277V) linear</p> <p>E4 * DMX 0.1%, UNV (120-277V) Universal DMX Driver/Controller RGBWW-DMX (INCLUDES DMX/RDM COMPATIBLE DRIVER WITH BUILT-IN DECODER - CONTROLLER BY OTHERS)</p> <p>LD Digital Ecosystem* 1.0%, UNV (120-277V) ECO Hi-Lume SoftOn/Fade-to-Black LDE1</p> <p>TR2 TruPhase™ 0.1%, (120-120V) log Up to 20W Forward and Reverse compatible Phase Dimming Static White & Ambient Dim only</p> <p>* Requires remote mounting</p>	<p>A01 Black Anodize</p>  <p>A32 Clear Aluminum Anodize</p>  <p>AXX Specialty Anodize colors*</p>  <p>W White Paint</p>  <p>PXX Specialty Paint Color*</p>  <p>C Custom/RAL Color Paint*</p>  <p>* See Finish Guide</p>	<p>A01 Black Anodize</p>  <p>A32 Clear Aluminum Anodize</p>  <p>AXX Specialty anodize color*</p>  <p>W White Paint</p>  <p>PXX Specialty Paint Color*</p>  <p>C Custom/RAL Color Paint*</p>  <p>K Blank for use with Flangeless or Panel Mount other than wood</p>  <p>* See Finish Guide</p>	<p>CP Chicago Plenum</p> <p>EM Emergency Pack</p> <p>Controls</p> <p>LR Lutron Wireless RF PowPak</p> <p>ATH Lutron Athena Wireless Node <i>Must be used with E2 driver (DALI-2)</i></p> <p>CA Casambi Wireless BLE to be paired with driver</p>



Fixture Details

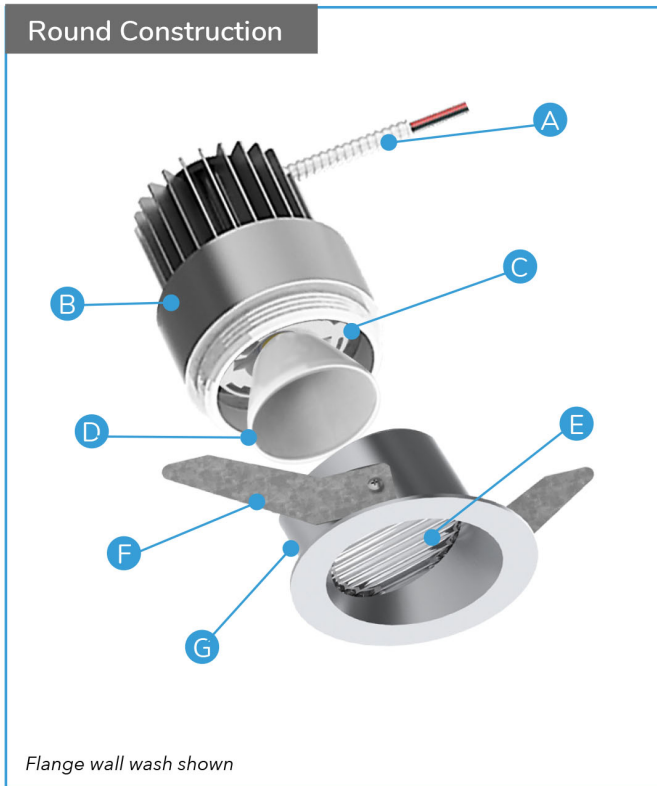

Flanged Finish Options

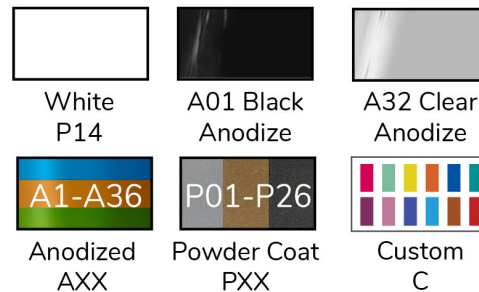

Standard Assembly Specs

- A** 22AWG wire to Driver. Enclosed in flexible conduit connected to driver enclosure.
- B** Thermal management system and body. High grade anodized aluminum, precision machined in the U.S.A.
- C** LED assembly- Field serviceable as part of thermal management system
- D** Primary optic- Field changeable
- E** Spreader Lens- Borosilicate glass
- F** Wing Spring- for attachment to sheetrock or other ceiling materials accomodating up to 1 1/4" ceiling thickness
- G** Receiver- High grade aluminum precision machined in the U.S.A. with integral flange
- I** Driver and enclosure – UL approved for IC- Requires remote mounting

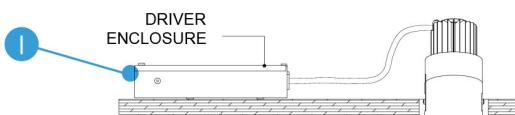

Ceiling Cutouts and Dimensions

No housing or pan for this product - attach direct to ceiling.

Round Remodel

Flanged Trim (F)

(SCO3WW-R-F-RM-)

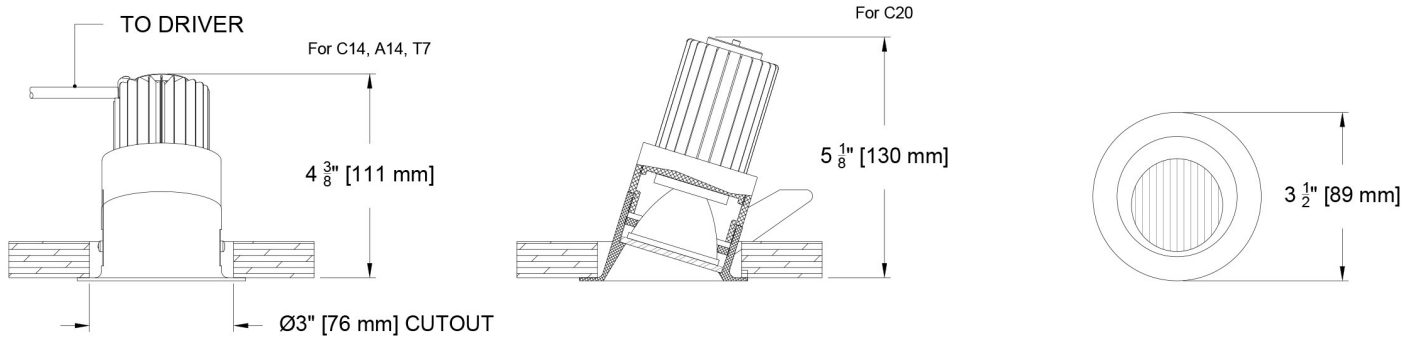

Driver Enclosure

for C1, C2, TR2

INTEGRAL WITH FIXTURE

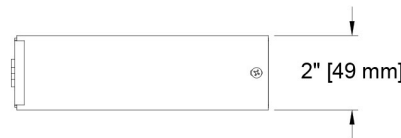
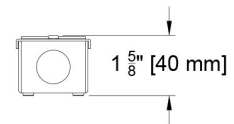
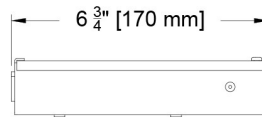
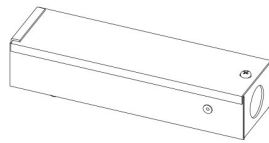

Driver Enclosure

for E1, E2, E3, E4, L3, LD

REMOTE MOUNTING REQUIRED

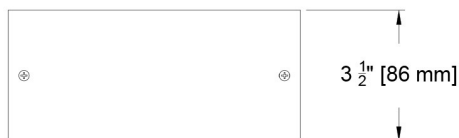
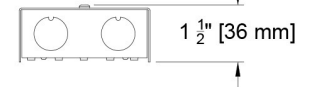
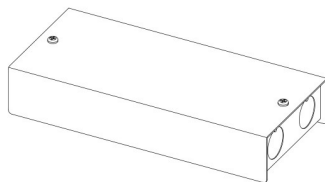

Photometric Table

All data are delivered lumens based on goniometer measurements of production representative product All values can vary +/-10% from source manufacturer rated flux range.

ROUND Wall Wash				
Source	System watts (W)	Delivered Lumens (lm)	Lumens/Watt	Peak CD
Citizen CZ14	14	1131	81	1443
Citizen CZ20	21	1540	74	9929
Ambient Dim AD14	15	778	53	1011
Tunable White 1840	10	505	49	753
Tunable White 2765	10	621	61	953

CCT Multiplier	
CCT	Citizen
2700	0.95
3000	1.00
3500	1.02
4000	1.03

All Measurements 3000K unless otherwise noted below. Ambient dim measured at full output. Tunable White measurements at mid-point CCT of range (2700k for 1840 and 4500k for 2765). All sources meet CA Title 24 JAB efficacy requirements.

Beam angle

45.8°

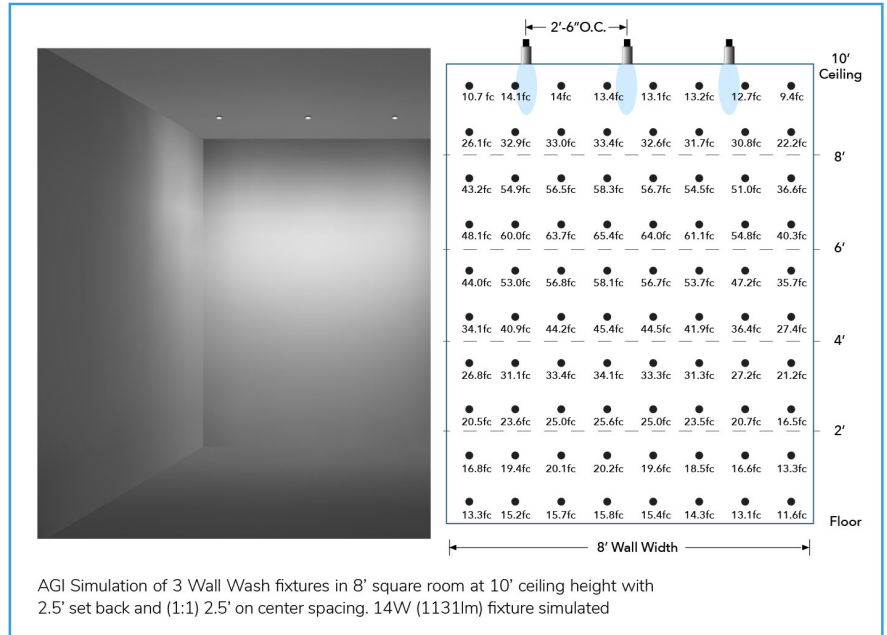

Color Data

All data below are delivered lumens. Color and flux information based on goniometer measurements of production representative product. All values can vary +/- 10% from LED manufacturer rated data range.

Citizen C14 and C20

- <2 MacAdam Ellipse (<2 SDCM)
- 90+ CRI and RF
- 60+R9, Hue Bin 1

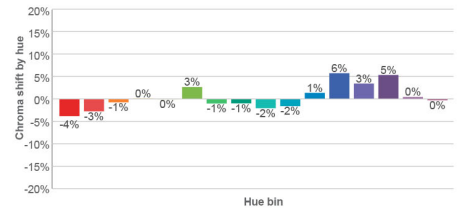
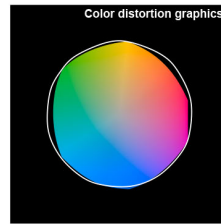
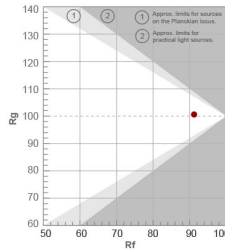
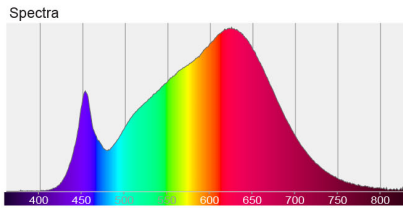
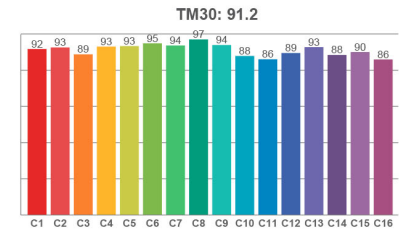
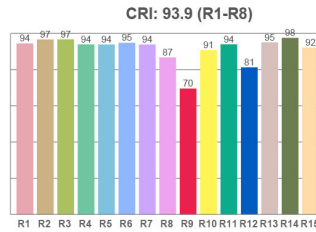
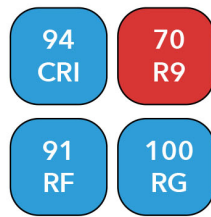

Ambient Dim - 3000k to 1900k

- <3 MacAdam Ellipse (<3 SDCM)
- 95+ CRI and RF
- 90+R9, Hue Bin 1
- Follows Black Body Locus through dimming range

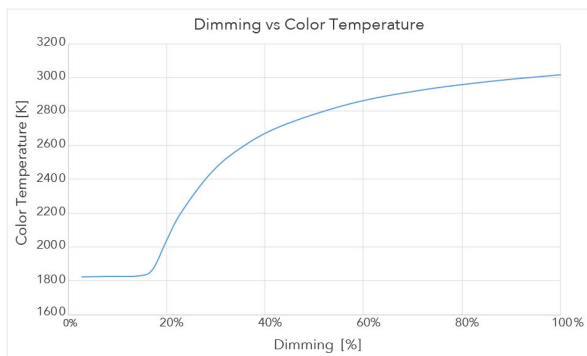

3000 CCT Full Output

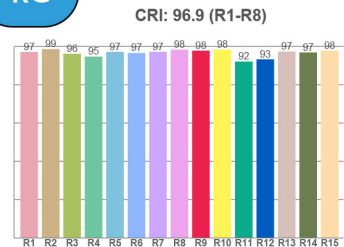
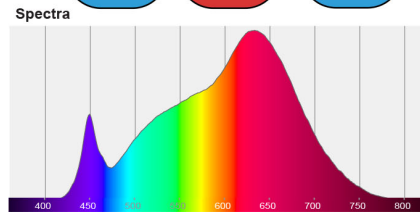

1850 CCT 5% Output

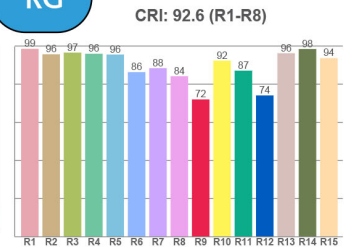
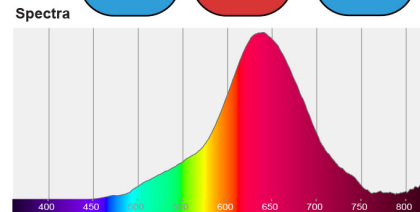
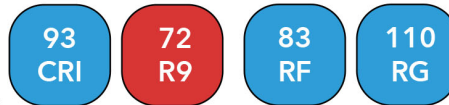

Tunable White - 1800k to 4000k

- <3 MacAdam Ellipse (<3 SDCM)
- 94 CRI average across all CCTs
- 76 R9 average across all CCTs
- Available in both wired or wireless control

Color Temp	TUNABLE WHITE - 1800-4000K						
	1800	2200	2500	2700	3000	3500	4000
System Watts	12	12	12	12	12	12	12
Delivered Lumens	422	475	502	517	536	564	585
Luminaire Efficiency	33	38	41	42	44	48	50

Flux and color data based on 2700 CCT 20° measurement. All values are delivered.

Spectral Power Distributions at all listed CCTs available upon request

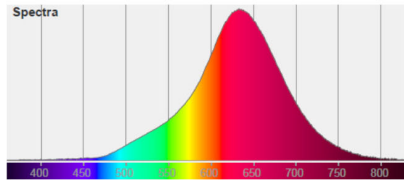

1800K

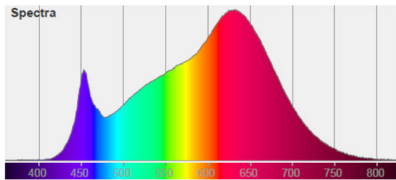

3000K

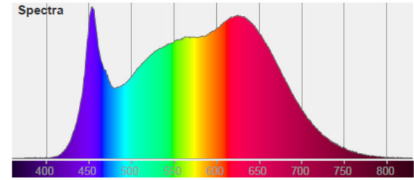

4000K

94
CRI

76
R9

89
RF

97
RG

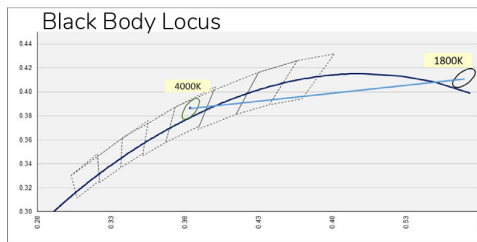

Tunable White - 2700k to 6500k

- <3 MacAdam Ellipse (<3 SDCM)
- 94 CRI average across all CCTs
- 96 R9 average across all CCTs
- Available in both wired or wireless control

Color Temp	TUNABLE WHITE - 2700-6500K								
	2700	3000	3500	4000	4500	5000	5500	6000	6500
System Watts	12	12	12	12	12	12	12	12	12
Delivered Lumens	586	597	611	618	622	626	622	619	621
Luminaire Efficiency	46	48	50	51	52	52	52	52	52

Flux and color data based on 20° measurement at 2700 CCT.

Spectral Power Distributions at all listed CCTs available upon request

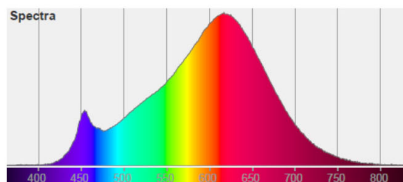

2700K

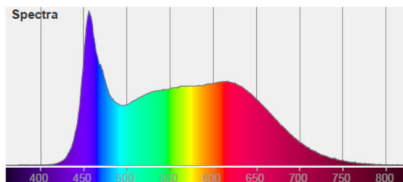

5000K

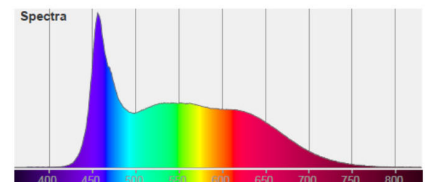

6500K

96
CRI

76
R9

91
RF

99
RG

